



cab product overview
Laser marking

XENO
Made in Germany

Key points first

Laser is economic when it comes to marking small components or even large workpieces precisely and permanent. There are several benefits:

- **Focus on smallest spaces,**
as laser beams allow strong bundling
- **Flexibility,** as both metals and plastics can be marked
– even on spots that are difficult to access
- **High speeds of operation,**
as strongly bundled light must not overcome mechanical resistance
- **No mechanical force** exerted on components,
as heat energy is brought in without direct contact
- **Highly resistant,** as laser marking is insensitive
to acids or bases, UV radiation, heat and wear

cab marking lasers have been designed to solve a wide range of applications. It is possible to mark stagnant products of metal or plastics in a wide range of industries:

- **Medtech** – machine-readable encoding of medical or surgical instruments, compliant with the guidelines on Unique Device Identification
- **Aerospace** – DataMatrix encoding of strategic components such as turbines
- **Electronics** – permanent encoding and alphanumeric data assure quality assurance of PCB, clamps or switch gears
- **Automotive** – laser encoding to track and trace automotive components and units; markings include, for example, manufacturing data, dates, part, series and batch numbers

Scopes of delivery, design and technical specifications correspond to the date of the printing. Subject to change. The data provided in the catalog do not represent any warranty or guarantee.



For current data see also the Internet:
www.cab.de/en/laser

Sample applications

cab marking lasers mainly work with metals and plastics.
Depending from the requirement and material, different methods are known:



Traceable QR encoding



Markings on cast parts

Engraving

Evaporation with high energy density removes the material.
An indentation with a sharp outline occurs.



Medical instruments

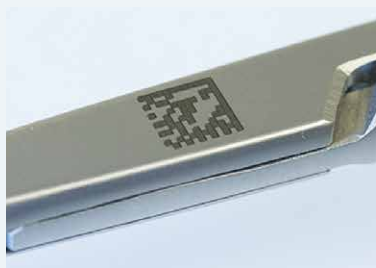

Traceable sterilization

Annealing

finds application mainly on highly alloyed stainless steel
or titanium.



Aluminum rating plates



Automotive components

Ablating

uncovers material underneath the top layer.
Examples include anodized or painted layers.



Consumption metering



Medical size allocation

Coloring

finds application on plastics. The degree of color change
depends from the chemical composition of the material as
well as from ingredients and fillers.

Marking lasers XENO 4

The performance and quality of markings mainly depend from the output power and the laser beam focus.

cab XENO 4 marking lasers are diode-pumped and air-cooled. They have high beam quality and high pulse peak powers. Beam sources are provided with 20, 30 and 50 Watt.

Different plano-spherical lenses enable marking in fields from 69 x 69 mm to 290 x 290 mm.

20, 30, 50 Watt

Marking is possible on plastics, metals and painted surfaces.

XENO 4 marking lasers consist of two units: A control unit with an integral beam source and a scan head that is connected with the beam source via a fiber. It can be assembled in any orientation.

The integrated focus finder simplifies workpiece positioning.

1.1 - 1.18

XENO 4 represents

- a compact scan head,
- high operation speeds,
- integrated focus finding,
- shifting the marking plane quickly,
- shifting the focus throughout height differences up to 140 mm,
- Industry 4.0,
- TCP/IP control and monitoring

The control unit and the beam source are incorporated in a 19" rack.



Interfaces providing process control and monitoring

- 1 **Ethernet 10/100 Base** to connect a PC. As delivered, the device has been configured with an IP address or in DHCP mode.
- 2 **Ethernet 10/100 Base** to connect peripheral devices. Bidirectional data transfer from and to end devices
- 3 + 4 **2 x RS232 C** to connect peripheral devices. Bidirectional data transfer from and to end devices
- 5 **Digital I/O interface** control and monitoring. Provided are 8 inputs and outputs, freely programmable. Circuit protected according to IEC 61131-2
- 6 **Remote** laser switch-on and control
- 7 **Interlock / E-stop** to integrate to external safety circuits and connect an external E-stop

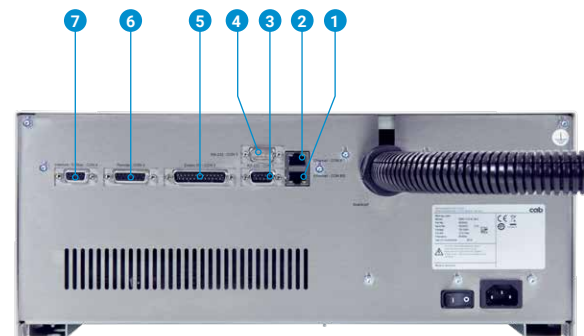

Shifting the focus with XENO 4S

By shifting the focus, XENO 4S can within fractions of a second effortlessly compensate height differences on a component.

By mechanical unit adjustment, even complex markings are possible on different levels of a component without loss of cycle time.

A control unit calculates the respective layout scaling. Depending from the plano-spherical lens in use, shifting is possible up to ± 70 mm.

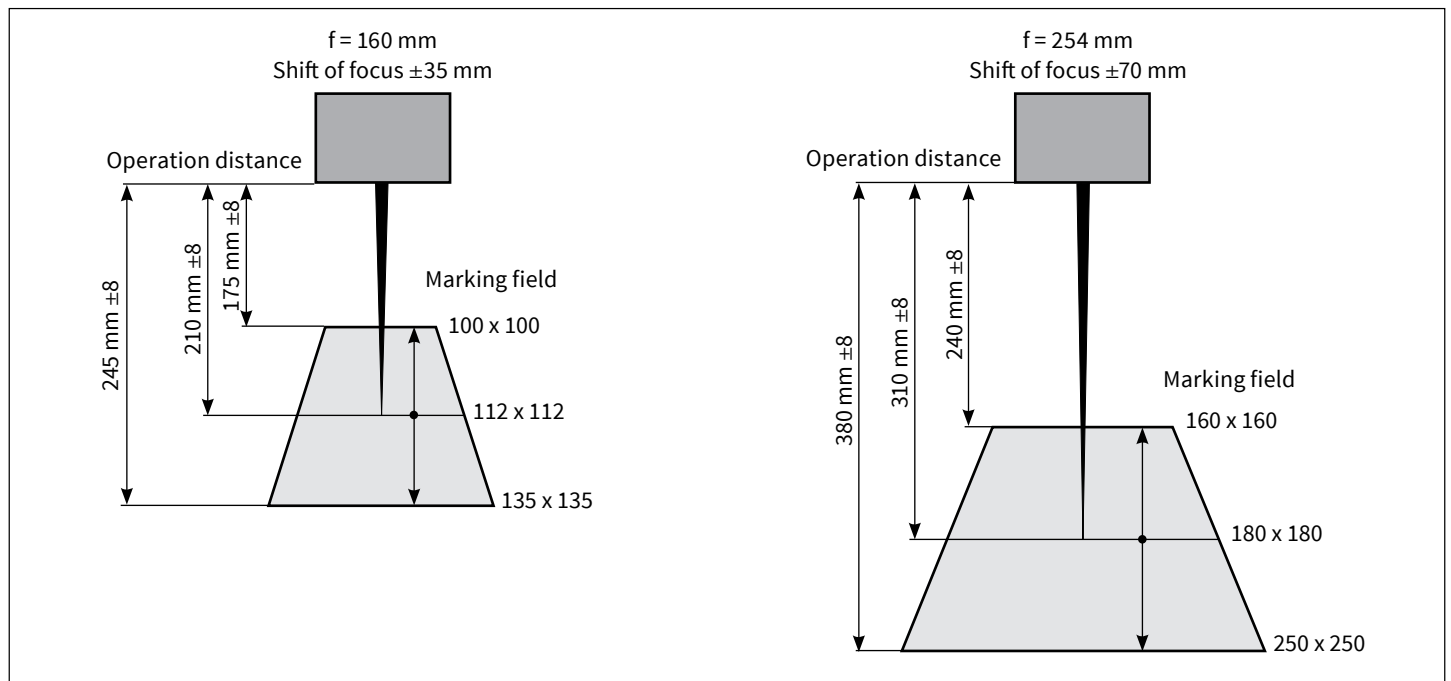
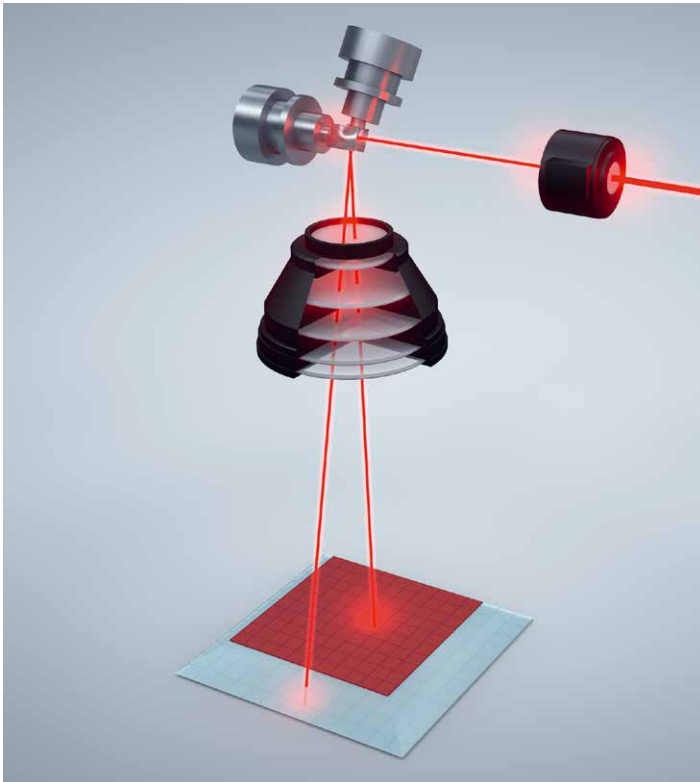

Technical data

		1.1 - 1.12			1.13 - 1.14	1.15 - 1.16	1.17 - 1.18
Marking laser		XENO 4 / 20	XENO 4 / 30	XENO 4 / 50	XENO 4S / 20	XENO 4S / 30	XENO 4S / 50
Beam source		Ytterbium fiber laser, pulsed, air-cooled					
cw output power	up to W	20	30	50	20	30	50
Pulse energy	mJ	1					
Wave length	nm	1,064					
Beam quality M ²		<1.8					
Pulse width	ns	<120					
Pulse repetition frequency	kHz	20 - 60	30 - 60	50 - 100	20 - 60	30 - 60	50 - 100
Connection cable	m	2.5					
Plano-spherical lens		XENO 4				XENO 4S	
Lens	Type	100.2	160.2	254.2	420.2	160.2	254.2
Operation distance	mm	149 ± 4	210 ± 8	310 ± 8	549 ± 20	210 ± 8	310 ± 8
Marking field	mm	69 x 69	112 x 112	180 x 180	290 x 290	100 x 100 @ +35 Shift 135 x 135 @ -35 Shift	160 x 160 @ +70 Shift 250 x 250 @ -70 Shift
Spot diameter	µm	~25	~35	~50	~85	~35	~50
= Resolution	dpi	1,000	725	500	300	725	500
Scan head		horizontal / vertical					
Assembly		horizontal / vertical					
Marking speed	mm/s	~5,000					
Shift of focus	mm	-	-	-	±35	±70	±70
Speed of shift of focus	mm/ms	-	-	-	0.5	0.3	0.3
Pilot laser							
Wave length	nm	650					
cw output power	mW	<1					
Electronics							
Processor 32 bit clock rate	MHz	600					
Main memory (RAM)	MB	256					
Data memory (Flash)	MB	512					
Dimensions and weights		Rack 4 height units 19"					
Control unit W x H x D	mm	420 x 178 x 420					
Weight	kg	16					
Scan head W x H x D	mm	99 x 135 x 205			99 x 155 x 260		
Weight	kg	3			4		
Operation panel							
Key switch		Beam source ON/OFF					
Buttons	Pilot laser / focus finder	ON/OFF					
	Shutter open	open / close					
Display	Emission	Beam source in operation					
	Laser error	Beam source error					
	Ready	Beam source ready					
	Power	Power supply ON					
	Pilot laser / focus finder	ON					
	Shutter open	Safety lock open					
Connections Service		USB mini					
Operating data							
Power supply		100-240 VAC, 50/60 Hz					
Power switch		ON/OFF					
Power consumption	Standby W up to W	200	200	350	200	200	350
Approvals		CE, FCC Class A					
Laser protection class EN60825-1							
	Beam source	Class 4					
	Pilot laser	Class 2					

Dimensional drawing

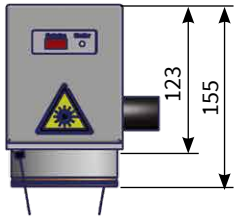

XENO 4S scan head

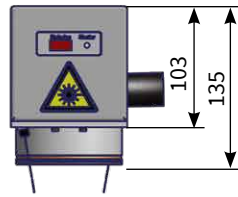

XENO 4 scan head

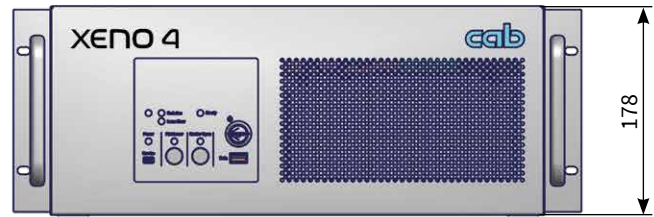

XENO 4 control unit

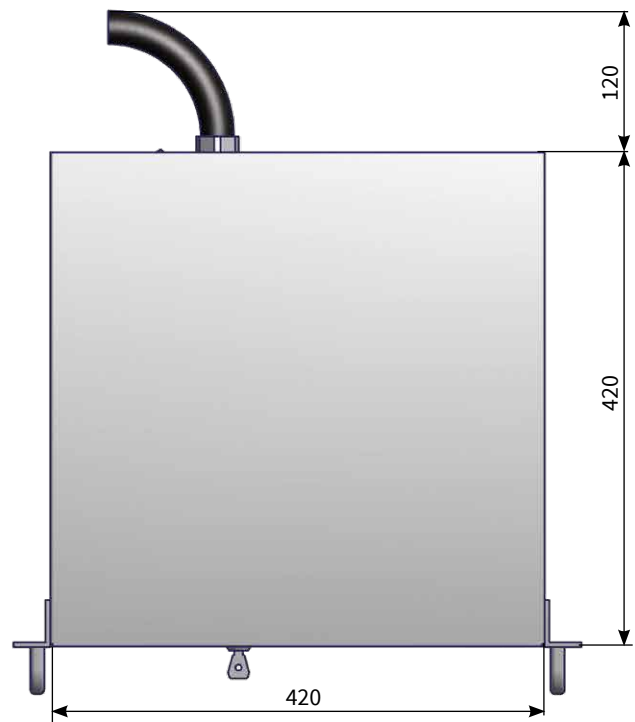
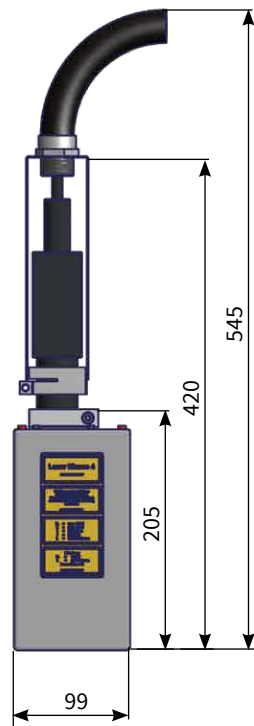
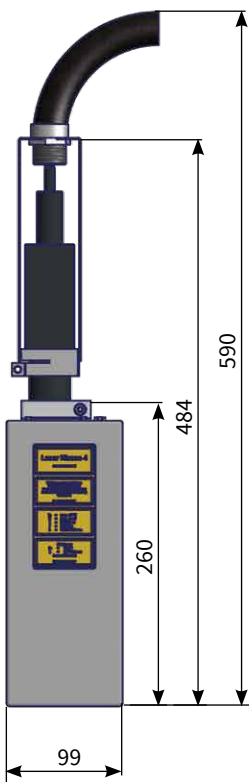

Laser marking system XENO 1



XENO 1 is a compact desktop system, demanding little footprint and offering a large work area.

XENO 1 fits with marking on metals or plastics.

XENO 1 completes the range of cab laser marking systems in the lower price segment. Processing the system complies with high industrial standards.

The marking plane is adjustable in heights up to 200 mm with the motor-driven moveable Z-axis and easily and quickly with the focus finder. In case of graduated marking surfaces, the scan head is automatically tracked by software.

Depending from the lens, the size of the marking field is 112 x 112 or 180 x 180 mm. It can be moved from the center to the right margin.

The marking can be simulated with the pilot laser.

Interior LED lighting allows observation of the workpiece when the operation door is closed.

The workpiece holder is mounted on the groove plate.

A rotary axis is available for cylindrical objects.

The automatic operation door opens or closes within seconds. Material can be inserted manually or by a handling system from three sides.

With the comprehensive cabLase marking software layouts are graphically designed, markings controlled and processes monitored.

Legal environmental regulations RoHS and REACH are observed.

	2.1	2.2	2.3	2.4	
Laser marking system XENO 1					
Beam source	Ytterbium fiber laser, pulsed				
cw output power	up to W	20	30		
Pulse energy	mJ	1			
Wave length	nm	1,064			
Beam quality M ²		<1.8			
Pulse width	ns	<120			
Pulse repetition frequency kHz		20 - 60	30 - 60		
Pilot laser / focus finder					
Wave length	nm	650			
cw output power	mW	<0,4			
Lens	Type	160.2	254.2	160.2	254.2
Operation distance	mm	210 ± 8	310 ± 8	210 ± 8	310 ± 8
Marking field	mm	112 x 112	180 x 180	112 x 112	180 x 180
Work area height	mm	200	100	200	100
Groove plate W x H x D x pitch mm		500 x 200 x 375 x 25			
Z-axis stroke, motor-driven	mm	210			
Position accuracy	mm	± 0,1			
Repetitive accuracy	mm	± 0,1			
Traversing speed	mm/s	20			
Interior lighting		LED			
Operation door		motor-driven opening / closing			
Workpiece weight	up to kg	30			
Dimensions and weight					
Device	W x H x D	mm			
	Weight approx.	kg			
Laser protection window	W x H	mm			
Extraction					
Nozzle flexible hose	DN	mm			
Suction pipe	DN	mm			
Operating data					
Power supply		100-240 VAC, 50/60 Hz			
Power consumption		Standby <35 W / typical 150 W / up to 200 W			
Approvals		CE, FCC Class A			
Laser protection class EN60825-1		Class 1			
Operation panel					
LED displays		Power, Ready, Emission, Error, Marking			
Buttons, illuminated		Control ON/OFF	Start		
		Focus finder ON/OFF	Z-axis up / down		
		Extraction ON/OFF	Rotary axis left / right		
		LED ON/OFF	Operation door open / closed		
Switch		E-stop			
Key switch		automatic / manual			
Monitoring					
Safety circuits		closed			
Collective error		Marking laser	Extraction system		
Interfaces					
Operation room		Rotary axis	Digital I/O interface		
Back of the device		2 x Ethernet TCP/IP	Extraction and filter system AF5		
		24 V for digital I/O interface	External start, external E-stop		

Accessory

6.7 **Extraction and filter system AF5**

8.6 **Linear axis X230**

Details

XENO 1 is a fully equipped laser marking system offering high operating comfort for marking single components and series.



- 1 **Fiber laser** 20 or 30 W
- 2 Motor-driven **operation door**
- 3 **Scan head**, providing motor-driven height setting and a pilot laser to preview the marking
- 4 **Focus finder** to set the marking plane
- 5 **Interior LED lighting**
- 6 **Rotary axis** with a 3-jaw chuck for markings on cylindrical items
- 7 **Digital I/O interface** control and monitoring, provided are 8 inputs and outputs, freely programmable
- 8 **Plug** to connect the rotary axis
- 9 **Operation panel** providing buttons and status display
- 10 **Groove plate** to clamp workpiece carriers
- 11 **Z-axis**, moveable along the groove plate
- 12 **Suction hose**

Interfaces

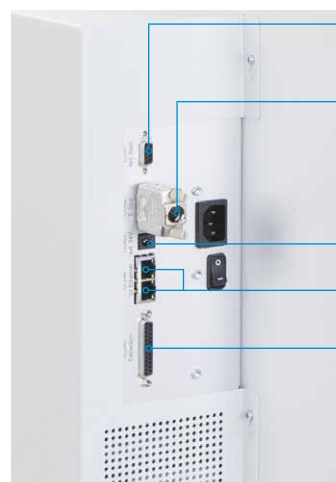

- 13 **External start signal**
- 14 **E-stop** to integrate into external safety circuits
- 15 **External 24 V** for additional operations
- 16 **2 x Ethernet 10/100 Base**
As delivered, the device has been configured with an IP address or in DHCP mode.
- 17 **Port to connect an extraction and filter system**

Laser marking system XENO 3



XENO 3 provides an integrated laser system to mark metal and plastic plates permanently.

Fiber laser beam source, control unit and operation room are incorporated in a joint laser safety housing according to protection class 1. Due to its compact design and small footprint, XENO 3 fits with desktop operations.

Markings applied by a XENO 3 remain clearly legible even in the long term in rough surroundings.

Hydraulic cylinders, engines, pumps, gears, vehicle chassis or system components are typical items to be marked with a XENO 3.

Replace magazines enable to process different plate sizes. Plates to be processed are 40 x 20 to 120 x 100 mm in size, resp. 0,5 to 1 mm in thickness.

Plate stacking is possible to heights of 50 mm.

The marking can be observed through the protection window and with the help of the lit interior.

Fold-out carry handles simplify the installation of the system.

With the comprehensive cabLase marking software layouts are graphically designed, markings controlled and processes monitored.

The system might be remote controlled or monitored in networks in which machines interact with other machines or human beings.

In the case of metal engravings and ablation of top layers we advise you on the selection of filters.

		3.1	3.2
Laser marking system XENO 3			
Beam source		Ytterbium fiber laser, pulsed	
cw output power	up to W	20	30
Pulse energy	mJ	1	
Wave length	nm	1,064	
Beam quality M ²		<1.8	
Pulse width	ns	<120	
Pulse repetition frequency kHz		20 - 60	30 - 60
Pilot laser			
Wave length	nm	650	
cw output power	mW	<0.4	
Lens	Type	160.2	
Operation distance	mm	210 ± 8	
Marking field	mm	112 x 112	
Interior lighting		LED	
Material			
Plates			
Width x Height	from mm	40 x 20	
	up to mm	120 x 100	
Plate tolerance according		ISO 2768-mk	
Position accuracy	mm	±0.2	
Plates 0.5 mm	quantity	100	
Plate thickness	mm	0.5 - 1.0	
Dimensions and weight			
Device	W x H x D mm	420 x 480 x 480	
	Weight approx. kg	< 35	
Laser protection window	W x H mm	100 x 200	
Extraction			
Nozzle flexible hose	NW mm	38	
Suction pipe	NW mm	50	
Interfaces			
Back of the device		2 x Ethernet TCP/IP, Extraction and filter system AF5, external start, external E-stop	
Operating data			
Power supply		100-240 VAC, 50/60 Hz	
Power consumption		Standby < 35 W / typical 150 W / up to 200 W	
Approvals		CE, FCC Class A	
Laser protection class EN60825-1		Class 1	
Performance level		d	
Operation panel			
LED displays		Power, Ready, Emission, Error, Marking	
Switch		E-stop	
Monitoring			
Operation door		open / closed	
Collective error		Marking laser Extraction system	
Software			
Marking software		cabLase Editor 5 cabLase automation	
Software operation		Start Pilot laser ON/OFF Extraction ON/OFF LED ON/OFF	

Accessories

3.3 Magazine, customer-specific

6.7 Extraction and filter system AF5

Details

XENO 3 is a fully equipped laser marking system offering high operating comfort for marking single plates and series.



- 1 **Fiber laser** 20 or 30 W
- 2 **Setup door**
- 3 **Operation panel** providing buttons and status display
- 4 **Scan head**, providing manual height setting and a pilot laser to preview the marking
- 5 **Interior LED lighting**
- 6 **Extraction**, integrated
- 7 **Carry handles**
- 8 **Typeplate handling module**
- 9 **Replace magazine**
- 10 **Output magazine**

Interfaces

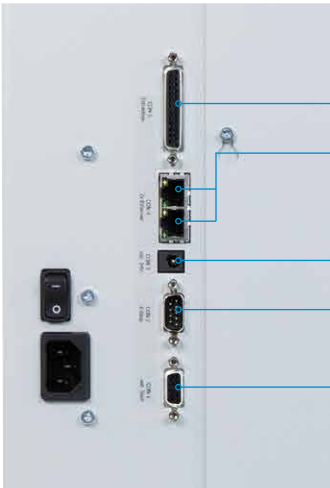

- 11 **Port to connect an extraction and filter system**
- 12 **2 x Ethernet 10/100 Base**
As delivered, the device has been configured with an IP address or in DHCP mode.
- 13 **External 24 V** for additional operations
- 14 **E-stop** to integrate into external safety circuits
- 15 **External start signal**

Laser safety housing LSG+100E

4.1 - 4.2



The laser safety housing LSG+100E offers an industrial solution for marking component series with a marking laser XENO 4. The rugged metal design besides a large work area provides enough space to integrate both the beam source and an industrial PC in a 19" assembly frame.

A keyboard and a monitor are assembled ergonomically to a pivot arm. The operation door opens and closes electrically.

	4.1		4.2	
Laser safety housing	LSG+100E 230 V		LSG+100E 120 V	
Operation room W x H x D mm	980 x 460 x 980			
Grooved plate, T-slot, W x D mm	550 x 375			
Pitch mm	25			
Z-axis stroke mm	440			
Position accuracy mm	0.02			
Repetitive accuracy mm	± 0.02			
Traversing speed up to m/s	60			
Interior lighting	Low energy light bulb			
Operation door	electrical opening / closing			
Time to open / close s	<2			
Lens Type	100.2	160.2	254.2	420.2
Marking field mm	69 x 69	112 x 112	180 x 180	290 x 290
Operation distance mm	141 ± 4	202 ± 8	302 ± 8	541 ± 20
Workpiece height up to mm	60 - 490	430	330	90
Workpiece height up to kg	50			
Dimensions and weight				
W x H x D mm	1,000 x 2,280 x 1,120			
Laser prot. window W x H mm	200 x 100			
Machine stands Ø mm	80			
Suction pipe Ø mm	50			
Frame to assemble XENO 4 and a PC	4 height units 19"			
Weight kg	395			

Operating data

Power supply	220-240 VAC, 50 Hz	100-140 VAC, 60 Hz
Power switch	ON/OFF	
Laser protection class EN60825-1	Class 1	
Approval	CE	

Operation panel

LED display	Power Ready	Emission Error	Marking
Buttons, illuminated	Control ON/OFF Focus finder ON/OFF Extraction ON/OFF Lighting ON/OFF Start Z-axis up / down X-axis left / right Rotary axis left / right Operation door open / close Reserve		
Switch	E-stop		
Key switch	automatic / manual		

Monitoring

Safety circuits	closed
Collective error	Marking laser Extraction system

Interfaces

Interlock / E-stop	XENO 4
Remote	XENO 4
Digital I/O interface	XENO 4
Stepper motor	Z-axis, X-axis, rotary axis
Extraction and filter system	AF5

Details



Setup door

A large setup door allows to access LSG+100E easily. Jigs may be assembled comfortably to the grooved plate in the well-lit operation room.

Linear axis Z400

It provides precise and fast focus setting. For setup, the axis is traversed with the help of buttons integrated to the operation panel.

Accessories

- 4.3 **PC in a 4 height units 19" rack**
- 4.4 **Monitor 19"**
- 4.5 **Standard keyboard, optical mouse**
- 4.6 **Keyboard with trackball**
- 6.7 **Extraction and filter system AF5**
- 8.1 on request: **Rotary table module RTM650**
- 8.6 **Linear axis X230**
- 8.9 **Linear axis X400**
- 8.10 **Rotary axis D30**
- 8.11 **3-jaw chuck D30**
- 8.15 **Axis controller 2S**

Laser label marker LM+



The laser label marker allows marking labels of different sizes straight from the roll precisely and cutting them out without the need of additional tools.

After the marking, labels made of laser markable foil can be cut or externally rewound.

Accessories

- 4.3 **PC in a 4 height units 19" rack**
- 4.4 **Monitor 19"**
- 4.5 **Standard keyboard, optical mouse**
- 4.6 **Keyboard with trackball**
- 5.3 **External rewinder**
- 5.4 **Hose set**
- 5.5 **Mobile cart**
- 5.6 **Console**
- 5.7 **Monitor column**
- 6.1 **Extraction and filter system AF1.1**

Laser label marker	5.1		5.2	
	LM+160.2		LM+254.2	
Operation room W x H x D mm	160 x 5 x 190			
Position accuracy mm	0.2			
Transport speed mm/s	200			
Interior lighting	LED			
Material	Label or continuous materials			
Thickness mm	0.055 - 0.3			
Weight up to g/m ²	500			
Width mm	25 - 120			
Label height up to mm	180			
Roll				
Outside diameter up to mm	300			
Core diameter mm	76			
Winding	outside / (inside on request)			
Lens Type	160.2	254.2		
Marking field mm	112 x 112	120 x 170		
Operation distance mm	210 ± 8	310 ± 8		
Dimensions and weight				
W x H x D mm	440 x 520 x 802			
Laser prot. window W x H mm	100 x 50			
Machine stands Ø mm	50			
Suction pipe Ø mm	50			
Weight kg	22			
Operating data				
Power supply	100-240 VAC, 50/60 Hz			
Power switch	ON/OFF			
Laser protection class EN60825-1	Class 1			
Approval	CE			

Operation panel	
LED display	Continuous material Labels
Buttons	Material feed Material backfeed Cut
Switches	automatic / manual E-stop
Monitoring	
Safety circuits	closed
Wipe-down roller	locked
Material	in marking position / no material
Interfaces	
Interlock / E-Stop XENO 4	
Serial RS232C XENO 4 CON5	
External E-stop	
Cutter	



Laser label marker LM+
on a mobile cart, providing an external rewinder on the console, a monitor column and an extraction and filter system AF1.1

cabLase marking software

cabLase Editor 5 features

- graphic layout design,
- marking control,
- process monitoring

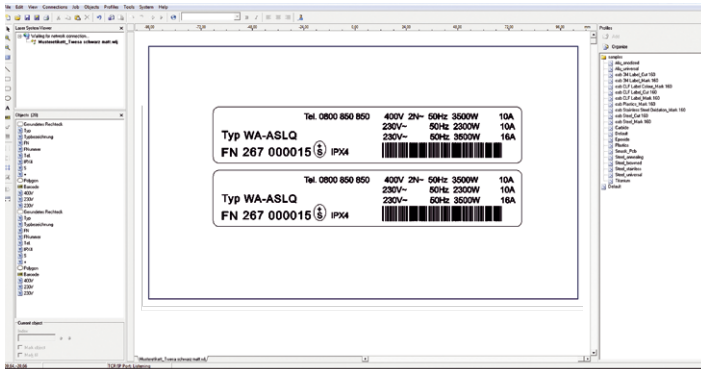

cabLase at a glance

Software		
Software	cabLase Editor 5	
Fonts		
Font types	All TrueType fonts included in Windows, filled or outline; laser typical single, double, triple line fonts. All font types can be freely scaled and “wobbled”.	
Alignment	Any alignment and direction of rotation, circular ark marking	
Character spacing	compress and stretch	
Graphics		
Graphic elements	Lines, circles, rectangles, polygons; hatching of all closed surface elements	
Graphic formats	PLT, DXF, BMP, JPG, PCX, WMF, EPS, TIF; All graphic elements can be scaled, moved, rotated, grouped or mirrored. Special tools are available to align the objects.	
Codes		
1D barcodes (linear)	Interleaved 2/5 Code 39, Code 93 Code 128	Codabar EAN UPC
2D codes	DataMatrix, ECC200, QR code	
	All codes are variable in height, modular width, ratio; check digit or inverted code output are options	
Further features		
Serial numbers, time, date		
Variable fields		
Add graphic data of Windows programs		
Program laser parameters		
Memory process data and parameters		
Control digital inputs and outputs		
Control and monitor additional axes, e.g. stroke, rotary and linear		
Recommended system requirements PC		
Operation system	Windows 10 (32/64 bit)	
Processor	Min. Intel Core i5-6400, recommended i7-6700 or higher	
Main storage	Minimum 8 GB, recommended 16 GB or higher	
Hard disc	Memory requirements software 1 GB	
Interfaces	Network card 10/100 Mbit for laser connection USB 2.0 connection for dongle	

Stand-alone operation

cabLase supports marking without the need of a PC. Marking layouts and related fonts are downloaded by the software to the laser control unit and managed. Digital signals provide process control and monitoring.

Remote host operation

cabLase allows remote control by a master control unit such as a PC or PLC serially, via Ethernet or ProfiBus. Programming commands are provided to select a layout, change marking data, control and monitor processes.

Remote API interface

if lasers are integrated in complex production processes. Objects and parameters, layouts and variable data can be set, administrated and processed externally via a PC or PLC.

COM automation server

for customer-specific marking applications. A library of commands provides all the functions of the cabLase marking software.

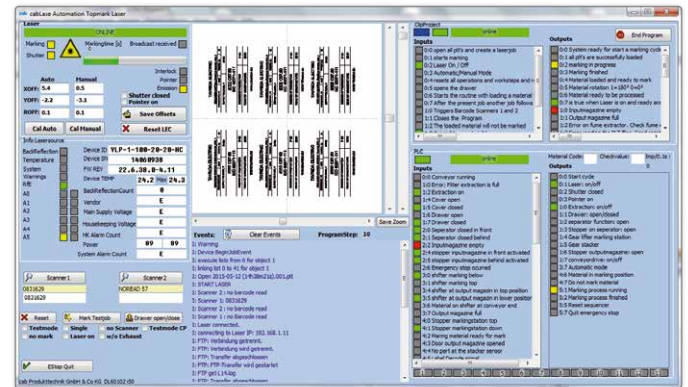

Integration in ERP and MES systems

cabLase provides program modules to integrate a marking system in MES and ERP platforms. As cab is a member of the SAP Printer Vendor Program, marking applications may be for example connected to the SAP data stream.

Industry 4.0

Industry 4.0 and the IoT represent smart production. Usable software and connectivity are implementation keys. Future-proof cab marking lasers provide all the interfaces necessary for programming and data transfer.
We gladly advise you in your application!

9.1 - 9.2



At delivery, all marking laser systems include a cabLase Editor 5 USB software dongle.

Extraction and filter system AF1.1 for LSG+100E and LM+

Processing materials with a laser produces poisonous dusts and gas pollutants. Extraction protects the operator's health and prevents the laser room and lens from contamination. It also ensures that laser power maintains. Air is extracted from the working room with the help of a highly performant turbine through a flexible hose.

Pollutants and dusts are emitted in the pre-filter and a filter particularly provided for suspended particles. Gas pollutants are absorbed by the active carbon filter. Clean air is returned to the environment.

The system has a modular design. Filters are easy to replace.



Consumables



Accessories

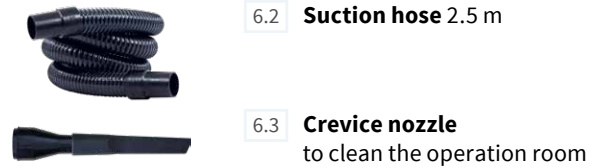

		6.1	
Extraction and filter system		AF1.1	
Suction power	up to m ³ /h	320	
Vacuum	bis Pa	12,500	
Filter equipment			
Filter class			
Pre-filter mat	M5	■	
Filter for susp. part.	H13	■	
Active carbon filter		■	
Dimensions and weights			
Device	Width	mm	355
	Height	mm	682
	Depth	mm	355
	Weight approx. kg		35
Suction pipe	NW	mm	50
Operating data			
Power supply			240 VAC, 50/60 Hz
Power consumption	Standby	W	<40
	typical	W	400
	up to	W	1,200
Approval			CE

Operation panel	
Display	LED Filter saturation Extraction ON/OFF Reset
Button 1	Run / Standby
Button 2	Reset
Control knob	Suction power
Interface	
	I/O interface
Monitoring	Run / Standby Trouble-free system operation Collective errors: - Temperature error - Turbine error - Filter saturated - Pre-filter error
Control	Run / Standby

Extraction and filter system AF5 for XENO systems

Processing materials with a laser produces poisonous dusts and gas pollutants. Extraction protects the operator's health and prevents the laser room and lens from contamination. It also ensures that laser power maintains. Air is extracted from the working room with the help of a highly performant turbine through a flexible hose.

Pollutants and dusts are emitted in the pre-filter and a filter particularly provided for suspended particles. Gas pollutants are absorbed by the active carbon filter. Clean air is returned to the environment.

The system has a modular design. Filters are easy to replace.

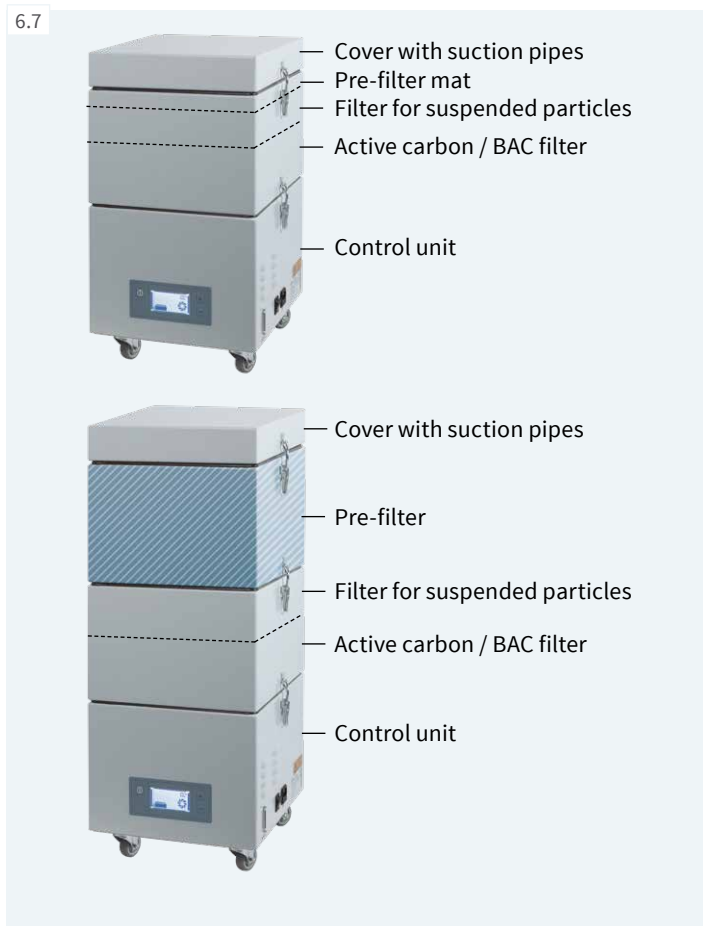

Consumables



Accessories



		6.7	6.8
Extraction and filter system		AF5	AF5 with a pre-filter module
Suction power	up to m ³ /h		230
Vacuum	up to Pa		11,000
Filter equipment		Filter class	
Pre-filter mat	F5	■	-
Pre-filter	F7	-	■
Filter for susp. part.	H13	■	■
Active carbon / BAC filter		■	■
Dimensions and weights			
Device	Width	mm	350
	Height	mm	647
	Depth	mm	350
	Weight approx. kg		40
Suction pipe	NW	mm	50
Operating data			
Power supply		100-240 VAC, 50/60 Hz	
Power consumption	Standby	W	<40
	typical	W	400
	up to	W	1,100
Approvals	CE, FCC, cETLus, W3, CAN ICES-3		

Operation panel	
Display	LED
	Filter saturation Extraction ON/OFF Reset
Button 1	Run / Standby
Button 2	Reset
Control knob	Suction power
Interface	
	Digital I/O interface
Monitoring	Run / Standby
	Trouble-free system operation
	Collective errors:
	- Temperature error
	- Turbine error
	- Filter saturated
	- Pre-filter error
Control	Run / Standby
	Suction power ±
	Reset

Accessories

7.1 - 7.4

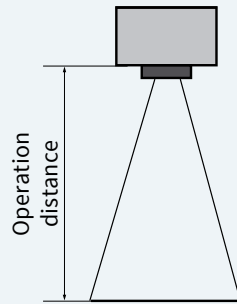

Plano-spherical lenses F-Theta XENO 4

Lenses are provided to cover different marking fields. The smaller the marking field, the higher the resolution.

Plano-spherical lens		100.2	160.2	254.2	420.2
To be used with		XENO 4	XENO 1 XENO 3 XENO 4/4S	XENO 1 XENO 4/4S	XENO 4
Operation distance	mm	149 ± 4	210 ± 8	310 ± 8	549 ± 20
Marking field	mm	69 x 69	112 x 112	180 x 180	290 x 290
Spot diameter	µm	~25	~35	~50	~85
Δ Resolution	dpi	1.000	725	500	300
Shift of focus with XENO 4S	mm	-	± 35	± 70	-
Shift of focus speed	ms/mm	-	0.5	0.3	-

7.5



Protective glass for F-Theta

The glass is assembled to the plano-spherical lens F-Theta. It can be replaced in the case of damage.

Protective glass		100	160	254	420
Outside diameter	mm	80	75	75	114

8.1

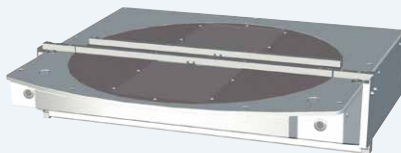

Rotary table module RTM650 for LSG+100E

to assemble two jigs for a single or more workpieces. 180° rotation is released by two-hand operation.

Rotary table module		RTM650		
Rotary table diameter	mm	650		
Plano-spherical lens	Type	100.2	160.2	254.2
Workpiece height	up to mm	360	300	150
Workpiece weight	up to kg	20 (incl. workpiece carrier)		
Switch accuracy		± 0.1 mm at = 600 mm		
Cycle time, rotating		2,5 s / 180°		

8.2

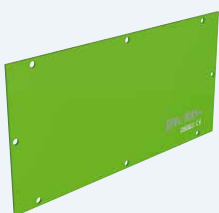

8.3

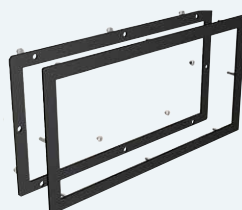

Laser protection window and assembly frame for LSG+100E

to be assembled in housings or doors to observe the marking process. The window may be assembled directly or with the help of the black anodized front panel and the back side frame behind the wall of the housing.

Laser protection window		100 x 200	
Assembly frame		100 x 200	
Diemsnions	Width mm	228	228
	Height mm	128	128
	Thickness mm	3	2

Accessories

8.4, 8.5



Linear axes Z400, Z200 for XENO 4
to position the scan head precisely.

Linear axis		Z400	Z200
Traversing distance	mm	440	200
Position accuracy	mm	0.05	0.05
Repetitive accuracy	mm	± 0.05	± 0.05
Traversing speed	up to mm/s	60	20
Dimensions W x H x D	mm	110 x 840 x 220	110 x 510 x 220
Load capacity	kg	10	7
Weight	kg	16	9

8.6 - 8.9



Linear axis X230 for LSG+100E and XENO 1
Linear axis X400 for LSG+100E

By traversing customer-specific workpiece or pallet carriers along the X-axis, a marking field can be extended.

Linear axis		X230	X400
Traversing distance	mm	230	440
Position accuracy	mm	0.05	0.05
Repetitive accuracy	mm	± 0.05	± 0.05
Traversing speed	up to mm/s	50	60
Dimensions W x H x D	mm	503 x 142 x 85	835 x 110 x 200
Load capacity	kg	15	50
Weight	kg	10	16
Cable to connect a linear axis		X230	
Length	m	1 (XENO 1), 2 (LSG+100E)	

8.10 - 8.12



Rotary axis D30 for LSG+100E
Rotary axis D30.1 for XENO 1

for markings on the circumference of cylindrical workpieces.
Workpiece clamping in the 3-jaw chuck

Rotary axis		D30 / D30.1
Rotational speed	U/min	0 - 40
Operating torque	Nm	12
Increment	at least [arcmin]	2,5
Holding torque	Nm	20
Through bore	Ø mm	15
Workpiece	Ø up to mm	160
Distance to the grooved plate	mm	84
Dimensions W x H x D	mm	125 x 105 x 128
Weight	kg	3
3-jaw chuck		D30
Clamping range	Ø inside mm	23 - 76
	Ø outside mm	3 - 76
Cable to connect a rotary axis		D30
Length	m	1

8.15, 8.16



Axis controller 2S for LSG+100E and XENO 4

to position the linear and rotary axes
with the help of a RS232 or the digital I/O interface.

Axis controller		2S
Dimensions W x H x D	mm	150 x 110 x 25
Interfaces for	Z-axis, rotary axis	
	digital I/O	for manual operation
	RS232	for automatic operation
Voltage		24 VDC
Cable to connect the axis controller		2S
Length	m	3

Delivery program

Pos.	Part no.	Devices
1.1	5528560	Marking laser XENO 4 20 W / 100.2 v.E.
1.2	5528430	Marking laser XENO 4 20 W / 160.2 v.E.
1.3	5528435	Marking laser XENO 4 20 W / 254.2 v.E.
1.4	5528570	Marking laser XENO 4 20 W / 420.2 v.E.
1.5	5528565	Marking laser XENO 4 30 W / 100.2 v.E.
1.6	5528440	Marking laser XENO 4 30 W / 160.2 v.E.
1.7	5528445	Marking laser XENO 4 30 W / 254.2 v.E.
1.8	5528575	Marking laser XENO 4 30 W / 420.2 v.E.
1.9	5528580	Marking laser XENO 4 50 W / 100.2 v.E.
1.10	5528585	Marking laser XENO 4 50 W / 160.2 v.E.
1.11	5528590	Marking laser XENO 4 50 W / 254.2 v.E.
1.12	5528595	Marking laser XENO 4 50 W / 420.2 v.E.
1.13	5528504	Marking laser XENO 4S 20 W / 160.2 v.E.
1.14	5528506	Marking laser XENO 4S 20 W / 254.2 v.E.
1.15	5528508	Marking laser XENO 4S 30 W / 160.2 v.E.
1.16	5528510	Marking laser XENO 4S 30 W / 254.2 v.E.
1.17	5528600	Marking laser XENO 4S 50 W / 160.2 v.E.
1.18	5528605	Marking laser XENO 4S 50 W / 254.2 v.E.
	Scope of delivery	Marking laser XENO 4 incl. lens USB software dongle Software cabLase Editor 5 Power cable Type E+F, 1.8 m Patch cable CAT 5e, 3 m E-stop dongle Assembly instructions DE / EN
Pos.	Part no.	Accessories
1.19	5528441	Adapter plate XENO 4/FL+
1.20	5528555	Adapter plate XENO 4S/FL+



Pos.	Part no.	Devices
2.1	5528130	Laser marking system XENO 1 20 W / 160.2 incl. lens
2.2	5528140	Laser marking system XENO 1 20 W / 254.2 incl. lens
2.3	5528150	Laser marking system XENO 1 30 W / 160.2 incl. lens
2.4	5528160	Laser marking system XENO 1 30 W / 254.2 incl. lens
	Scope of delivery	Laser marking system XENO 1 incl. lens USB software dongle cabLase Editor 5 Power cable Type E+F, 1.8 m Patch cable CAT 5e, 3 m E-stop dongle Operator's manual DE / EN
Pos.	Part no.	Devices
3.1	5528610	Laser marking system XENO 3 20 W / 160.2 incl. lens
3.2	5528615	Laser marking system XENO 3 30 W / 160.2 incl. lens
	Scope of delivery	Laser marking system XENO 3 incl. lens USB software dongle cabLase Editor 5 Power cable Type E+F, 1.8 m Patch cable CAT 5e, 3 m E-stop dongle Operator's manual DE / EN
Pos.	Part no.	Accessory
3.3	5528608	Magazine, customer-specific



Delivery program

Pos.	Part no.	Devices
4.1		5528090 Laser safety housing LSG+100E 230 V
4.2		5528095 Laser safety housing LSG+100E 120 V
Scope of delivery		Laser safety housing LSG+100E Power cable Type E+F, 1.8 m Conn. cable, 9/9 pins, 3 m, for Interlock / E-Stop Conn. cable, 9/9 pins, 3 m, for Remote Conn. cable, 25/25 pins, 3 m, for I/O interface Conn. cable, 15/15 pins, 3 m, for extraction Pivot arm to assemble a monitor/keyboard tray Assembly instructions DE / EN
Pos.	Part no.	Accessories
4.3		5570125 PC in 19" housing 4 height units, DE
		5570135 PC in 19" housing 4 height units, EN
4.4		5570130 Monitor 19"
4.5		5901626 Standard keyboard USB, DE
		5901677 Standard keyboard USB, EN
		5901658 Optical mouse
4.6		5901621 USB keyboard with trackball, DE
		5901651 USB keyboard with trackball, EN

Pos.	Part no.	Devices	
5.1		5528670 Laser label marker LM+ 160.2 for XENO 4	
5.2		5528675 Laser label marker LM+ 254.2 for XENO 4	
Scope of delivery		Laser label marker LM+ Power cable Type E+F, 1.8 m Conn. cable, 9/9 pins, 3 m, for Interlock / E-Stop Conn. cable, 9/9 pins, 3 m, for Remote Conn. cable, 25/15 pins, 3 m, for extraction Funnel to include scan head Guide 1 mm for foil intake Führung 2 mm for foil intake Cutter Extraction closure Throttle-valved hinge for extraction Assembly instructions DE / EN	
Pos.	Part no.	Accessories	
5.3		5525355 External rewinder ER 4/300 LM	
5.4		5527655 Hose set LM+	
5.5		5527585 Mobile cart	
5.6		5527675 Console R/L	
5.7		5527705 Monitor column	
Pos.	Part no.	Extraction and filter system AF1.1	
6.1		5907275 Extraction and filter system AF1.1 incl. filter set and a power cable Type E+F, 2.5 m integrated	
Scope of delivery		Extraction and filter system AF1.1 incl. filter set Operator's manual DE	
Pos.	Part no.	Accessories	
6.2		5905818 Suction hose, 2.5 m	
6.3		5907174.001 Crevice nozzle	
Pos.	Part no.	Consumables	Pack unit
6.4		5906617.001 Pre-filter mat	10
6.5		5906618.001 Filter for suspended particles	1
6.6		5906619.001 Active carbon filter	1

Delivery program

Pos.	Part no.	Extraction and filter system AF5	
6.7		5907550 Extraction and filter system AF5 incl. filter set	
Scope of delivery		Extraction and filter system AF5 incl. filter set Suction hose Crevice nozzle Power cable Type E+F, 2 m Cable SUB-D25 male/male, 3 m Operator's manual DE / EN	
Pos.	Part no.	Accessories	
6.3		5907174.001 Crevice nozzle	
6.8		5907570 Pre-filter module incl. pre-filter	
6.9		5907537.001 Suction hose, 2.5 m	
Pos.	Part no.	Consumables	Pack unit
6.10		5906555.001 Pre-filter mat	10
6.11		5907575.001 Pre-filter	1
6.12		5906569.001 Filter for suspended particles	1
6.13		5906570.001 Active carbon / BAC filter	1

Pos.	Part no.	Spare parts
7.1		5527846.001 Plano-spherical lens F-Theta 100.2 69 x 69 mm
7.2		5527847.001 Plano-spherical lens F-Theta 160.2 112 x 112 mm
7.3		5527848.001 Plano-spherical lens F-Theta 254.2 180 x 180 mm
7.4		5527849.001 Plano-spherical lens F-Theta 420.2 290 x 290 mm
7.5		5528305.001 Protective glass for F-Theta 100
		5528310.001 Protective glass for F-Theta 160 and 254
		5528315.001 Protective glass for F-Theta 420

Pos.	Part no.	Accessories
8.1		on request Rotary table module RTM650
8.2		5907189 Laser protection window 100 x 200 mm
8.3		5527416 Assembly frame 100 x 200 mm
8.4		5527695 Linear axis Z400
8.5		on request Linear axis Z200
8.6		5528986 Linear axis X230
8.7		5528906 Connecting cable X230 XENO 1
8.8		5528987 Connecting cable X230 LSG+100E
8.9		5527690 Linear axis X400
8.10		5905933 Rotary axis D30
		5906350 Rotary axis D30.1 incl. connecting cable and axis controller
8.11		5905978 3-jaw chuck D30
8.12		5526156 Connecting cable D30
8.13		5528250.001 E-stop dongle
8.14		5528368 Foot switch
8.15		5527685 Axis controller 2S
8.16		5527665 Connecting cable 2S
8.17		5527478 Adapter cable set FL-PCI
8.18		5527479 Adapter cable set FL-TCP
Pos.	Part no.	Software
9.1		5526096.001 USB software dongle cabLase Editor 5
9.2		5526094 USB software dongle cabLase Editor 5, Save Only

Overview of cab products

Label printers
MACH1, MACH2



Label printers
EOS 2



Label printers
EOS 5



Label printers
MACH 4S



Label printers
SQUIX 2



Label printers
SQUIX 4



Label printers
SQUIX 6.3



Label printers
SQUIX 8.3



Label printers
XD Q double-sided



Label printers
XC Q two-colored



Print and apply systems
HERMES Q



Print and apply systems
Hermes C two-colored

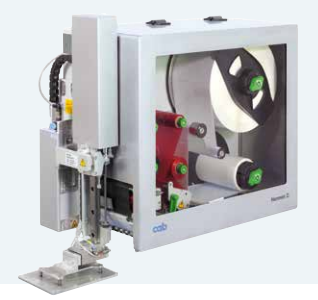

Tube labeling systems
AXON 1



Print modules
PX Q



Labels and ribbons



Label software
cablabel S3



Label dispensers
HS, VS



Labeling heads
IXOR



Marking lasers
XENO 4



Laser marking systems



Germany
cab Produkttechnik GmbH & Co KG
Karlsruhe
Phone +49 721 6626 0
www.cab.de

France
cab Technologies S.à.r.l.
Niedermodern
Phone +33 388 722501
www.cab.de/fr

USA
cab Technology, Inc.
Chelmsford, MA
Phone +1 978 250 8321
www.cab.de/us

Mexico
cab Technology, Inc.
Juárez
Phone +52 656 682 4301
www.cab.de/es

Taiwan
cab Technology Co., Ltd.
Taipei
Phone +886 (02) 8227 3966
www.cab.de/tw

China
cab (Shanghai) Trading Co., Ltd.
Shanghai
Phone +86 (021) 6236 3161
www.cab.de/cn

Singapore
cab Singapore Pte. Ltd.
Singapore
Phone +65 6931 9099
www.cab.de/en

South Africa
cab Technology (Pty) Ltd.
Randburg
Phone +27 11 886 3580
www.cab.de/za

cab // 820 distribution and service partners in more than **80** countries



cab
we identify more